

Interface instruction

Input interface:



- ① It is the reset button, when the controller crash, can touch this key to reset.
- ② It is USB signal joint entrance, when epistatic machine model after editing, can through the USB line to download to the controller.
- ③ It is DC plug, when the load power is small, can choose this port to input voltage.

Output interface:

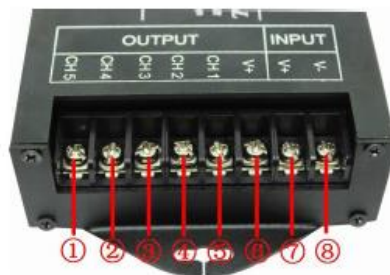

- ① It is the load output 5th channel negative pole;
- ② It is the load output 4th channel negative pole;
- ③ It is the load output third channel negative pole;
- ④ It is the load output second channel negative pole;
- ⑤ It is the load output first channel negative pole;
- ⑥ It is the load output common anode;
- ⑦. ⑧ It is power supply input positive and negative pole, when the load power is too large, you can choose this 2 port. (Remark: you only need to choose one between power supply input port and this 2 port)

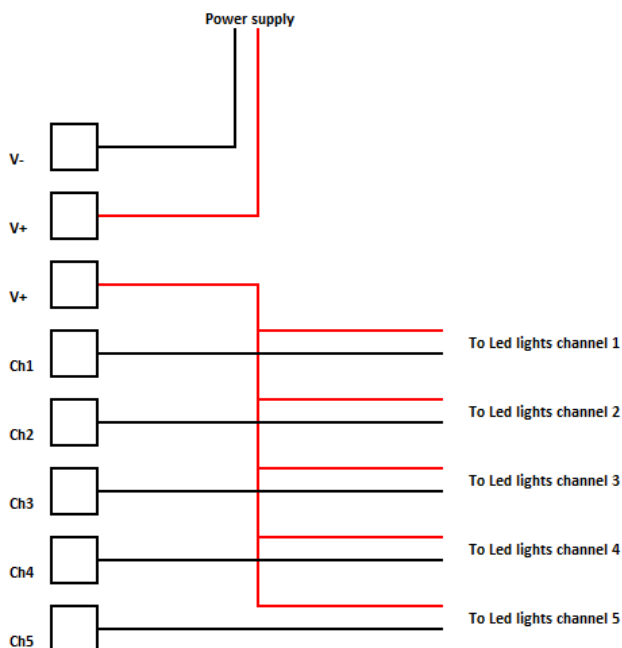

Dimmer LTD3

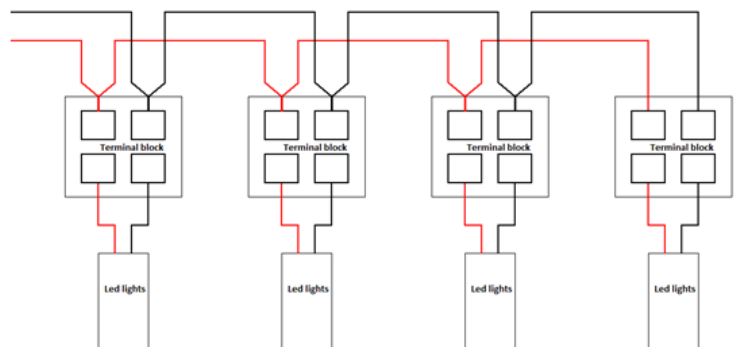

Function instructions

There are two kinds of modes like energy saving mode and setup mode in this controller , and also there are four buttons such as "Menu", "Enter", "+", "-" in it.

1. Power saving mode

When the controller in the situation of setup mode without any key press in 30 seconds , the screen background light will be closed, and if within 30 seconds there is still no any key press, the controller will go into the energy saving mode .

When the controller is in the energy saving mode, the first line of the screen shows that the current date and mode; the second line displays the current time.

Energy saving mode is as shown in figure 1:

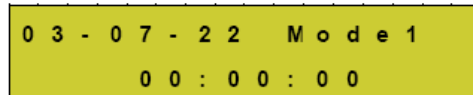

Figure 1

2. Setup mode

- ① Press "Menu" button in the main menu, it will enter into the time display interface.

The first line of the time display interface shows the current time or date and mode, it will automatically switch every two seconds .

The second line shows that "[Menu]", press "Enter" button to access the main menu interface.

Time display interface is as shown in figure 2:

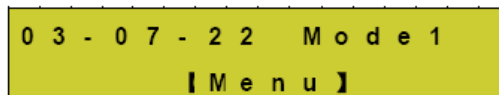

Figure 2

- ② When press "Enter" button in the time display interface , or "Menu" button in the submenu of the main Menu , it will go into the main Menu.

The first line shows the location of " [Menu] "in the main Menu of the display .

The second line of the display shows "1. Mode", "2. Setup" or "3, Run", that you can switch each mode by pressing the key "+" and "-" .

Press "Enter" button,it will access the corresponding setting mode ; and press the "Menu" button to return to the time display interface .

The main menu display is as shown in figure 3:

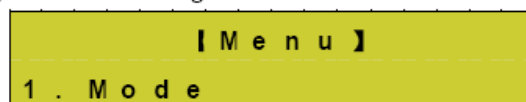

Figure 3

- ③ Select "1. Mode" in the main menu and press "Enter" button to go into the mode choice options .

The first line of the display shows the location of " 【Mode】 " in mode selection status .

The second line shows that the name of mode choice such as: "Mode11" .

Press the "+" or "-" key to choose mode , and save the selection mode ; Press the "Menu" button to return to the main menu.

The mode choice of display is as shown in figure 4:

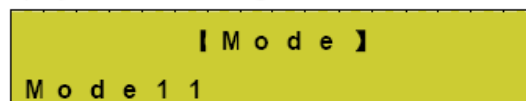

Figure 4

As standard, the following programs (mode) are programmed in the dimmer, all with the desired switching time

50, 60, 70, 80, 90 and 100. Night lighting 0% (The number the light intensity in %)

50 a, 60 a, 70 a, 80 a, 90 a and 100 a Night lighting 2% (The number the light intensity in %)

- ④ Select "2. Setup" in the main menu and press "Enter" button to go into the Setting menu ;
 The first line of the screen shows the location of " **【Setup】** " in the setting menu status .
 The second line of the display shows "1. Time" and "2. Date" or "3. Sound", you can select setting object through the key "+" or "-" .
 Press "Enter" button to access the corresponding Settings, and click "Menu" button to return to the main Menu.

Setting menu is as shown in figure 5:

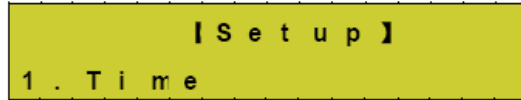

Figure 5

I. In the status of setting menu , choose "1. Time" and press "Enter" button, it will enter into time setting mode;

The first line of the screen shows the location of " **【Time】** " in the time setting status .

The second line of display shows the setting time ": hour: minute : second", for instance , "11:16:56" is the current setting time.

Press "Enter" button to choose every setting number (hour / minute /second) , as you seen ,in editing state , the selected area will be flashing .

Press the key "+" to add 1 , when the number reach maximum , it will return around to the Minimum value ;

Press the key "-" to reduce 1 ,when the number reach minimum , it will be back to the maximum value .

Press the "Menu" button to save and return to the setting menu .

Setting mode displays as shown in figure 6:

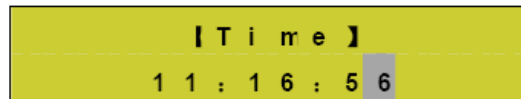

Figure 6

II. In the status of setting menu , choose "2.Date" and press "Enter" button, it will enter into date setting mode;

The first line of the screen shows the location of " **【Time】** " in the date setting status .

The second line of display shows the setting date " year - month - day " , for instance "13-01-01" is The current setting date .

Press "Enter" button to choose every setting number (year / month / day), as you seen ,in editing state , the selected area will be flashing .

Press the key "+" to add 1 , when the number reach maximum , it will return around to the Minimum value ;

Press the key "-" to reduce 1 ,when the number reach minimum , it will be back to the maximum value .

Press the "Menu" button to save and return to the setting menu .

Setting mode displays as shown in figure 7:

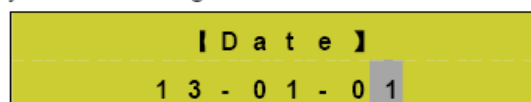

Figure 7